

ELECTRONIC TRANSFORMERS

- A. Plug-In 12V Electronic Transformer 120V 60Watt Dimmable
8' Detachable Cord Non-Detachable Cord
ETP60 -black
ETP61 -white
LVT -01 -60W
- B. ETP62 -Black. Plug-In 12V With Hi-Lo Switching 50W/30W
3-Wire SVT 8' Detachable Cord
- C. MLET7524R -Input 120V 60hz Output 24V Max load 75W
- D. MLET15124 -Input 120v 60hz Output 24V Max load 150w
- E. MLET30324 -Input 120v 60hz Output 24V Max load 300W
- F. LED DC Transformers Input 90-277V 50/60hz Load 1-25VA
Thermal and Short Circuit Protection Dimensions 1-1/4" x
1-13/16" x 4-1/16" UL & cUL Class 2
MLED2512 -12vdc
MLED2524 -24vdc
- G. Electronic Transformers 2-9/16" L x 1-3/8" W x 1-1/4" H
ET60 -60W
ET80 -80W
- H. Electronic Transformers 5-1/4" L x 1-3/4" W x 1-3/8" H
ET100 -100W
ET150 -150W
- I. Electronic Transformers 2-1/2" L x 1-1/4" W x 3/4" H
LVT-50R -50W
- J. Electronic Transformers 3" L x 1-1/4" W x 7/8" H
LVT-60N -60W
- K. Electronic Transformers 4-3/8" L x 1-7/8" W x 1-1/4" H
LVT-75B -75W
- L. Electronic Transformers 2-5/8" L x 1-3/8" W x 7/8" H
BSET60 -60W
BSET75 -75W
- M. Electronic Transformers L 2-1/2" x W 1-1/4" x D 13/16"
LET150 -150W 120V 12V
LET75-277 Input 277V Output 12V 75W
LET300 -300W 120V 12V
LETNS -120 75W 120V 12V
- N. Electronic Transformers 4-3/8" L x 1-7/8" W x 1-1/4" H
BSET105 -105W
BSET150 -150W

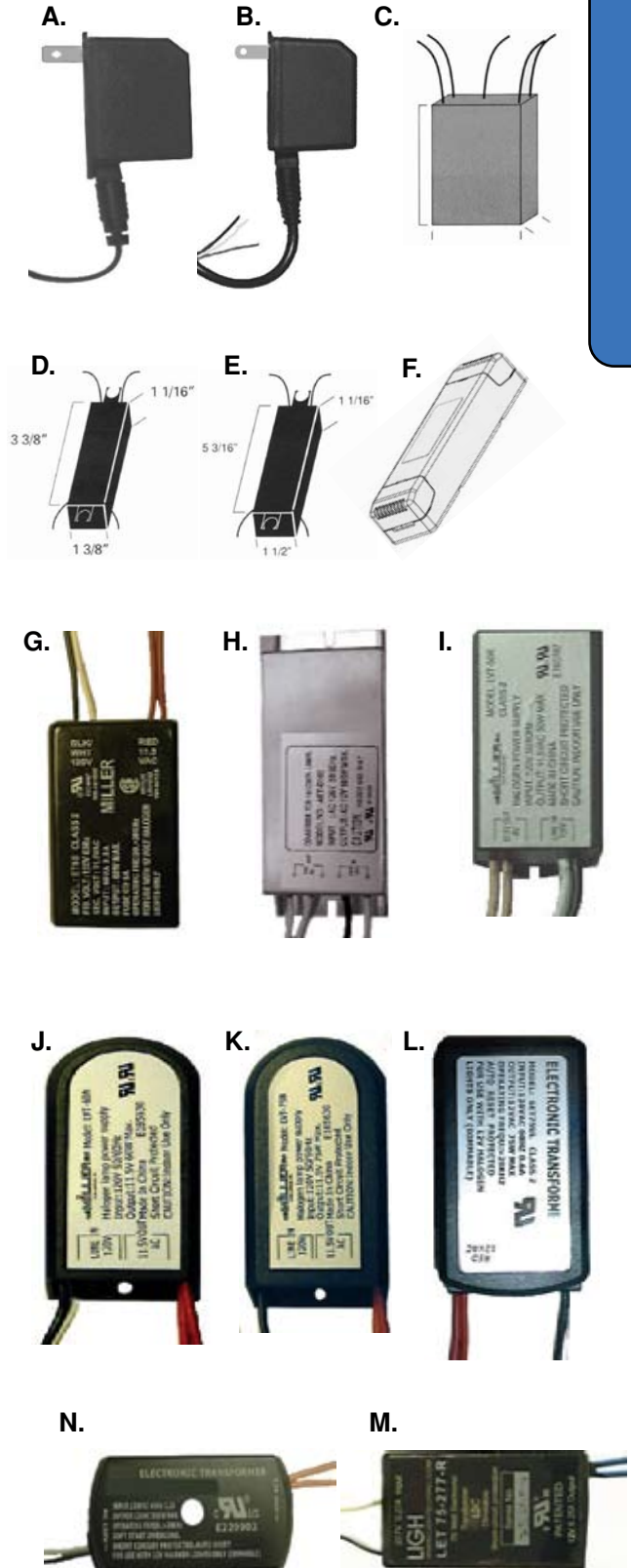

ELECTRONIC

USA & CANADA

1-800-445-6611

FAX WATS 1-800-445-6690



PHOENIX, AZ

Phone: 602-268-0001

Fax: 602-268-0130

Visit us online at: www.lightingparts.com

E-mail us at: customerservice@lightingparts.com

SWITCHES, DIMMERS, & PLUGS

- A. Rotary Turn (single circuit) 6A-125V AC 3/8" shank
L577-3N -nickel L577-3B-brass
5/8" shank
- B. Toggle (single circuit) 6A-125V AC
L720-T -nickel
- C. Pushbutton (single circuit) 3A-125V AC
L679-B -brass L679-N -nickel
- D. Rotary Turn (2 circuit, 4 position) 6A-125V AC Off, L-1, L-2, L-1-2
3/8" shank
L663-20B brass L663-20N -nickel
- E. Fluorescent Starter push button
40W 125V AC
L388 -nickel
- F. Pull Chain 2-circuit LO-MED-HI-Off
6A 125V AC
E460 -2-circuit
- G. Rotary (single circuit) bushing
mounted 3A-125V AC
L574T25W -white L574T25BL -black
- H. Pull Chain (single circuit) 3A-125V AC
L10097-8B -brass L10097-8N -nickel
- I. Pull Chain (3 circuit, 4 position)
push-in terminals for #18 wire 6A-125V AC 3
Circuit OFF, L-1, L-2, L-3
L1691 -brass
- J. Pull Chain (2 circuit, 4 position) 6A-125V AC 1/4 HP-125/250V AC heavy
duty push-in terminals 2 Circuit Off
L-1, L-2, L-1-2
L1689 -nickel
- K. Feed-thru Cord Switch 6A-125V AC
use with SPT-1
L413W -white
L413B -brown
L413BLK -black
L413I -ivory
wire use with SPT-2 wire
L423W -white
L423B -brown
L423BL -black
- L. Feed-thru Cord Switch heavy duty
single pole flat or round cords 15A
@ 120V ac
L5410 I -ivory
L5410 -brown
- M. SPT-2 In Line Switch 6A -120V AC
L412B -brown L412G -gold
L412C -clear L412BL -black
L412WH -white
- N. Triple Tap 15A-125V
L697-I -ivory
L697-I -brown
- O. Appliance Switch 15A 125VAC
MZE215 -on/off
- P. D555UNB-(black) Foot on/off Switch
(unassembled) parts packed
separately 3A/360W-120V AC
- Q. Snap-in Convenience Outlet 15A-125V
2 pole, 3 wire grounding
L1374BL -black
L1373W -white
- R. Academy Easy Install Plugs 15A-125V
Use with 18/2 SPT-1 Wire
Non-Polarized
L779 -brown
L780 -white
L781-black
Polarized
L782 -brown
L783 -white
L807 -black
- S. L113 -Rubber Plug Wire Sizes 18-14
Black Only 15A-125V
- T. Attachment Plug 15A-125V
Use with 18/2 SPT-1 Wire Polarized
L763 -brown
L765 -white
Use with 18/2 SPT-2 wire Polarized
L763-2 -brown
L765-2 -white
- U. Kwik Wire Pin Type 10A-125V
Polarized
L123PB -brown
L123PI -ivory
L123PE -black
L123PW -white
- V. Attachment Outlet Polarized 15A-125V
use SPT-1 wire
L760 -brown
L761 -ivory
L762 -white
use SPT-2 wire
L760-2 -brown
L762-2 -white
- W. L274 -Grounding Adapter 15A-125V
- X. Premium Industrial Specification Grade
accepts up to #10 AWG conductors 2
pole, 3 wire grounding color black.
L5266N -15A-125V
- X1. L5269N -15A-125V
- Y. E1008 -Socket Flasher Button Medium
Sockets Only Flash Rate 65-85 per
minute 60W 120V
- Z. Super Plug use with SPT-2, 18 or 16
ga. wire 15A-125V
Polarized
L790 -white
L791 -brown
Non-Polarized
L790W -white
L791B -brown
- AA. Add-A-Outlet 10A-125V Polarized
L808 -brown
L809 -white
- BB. L125 Outlet Adapter 660W-125V
- CC. Outlet Adapter 660W 125V
L61B -brown
L61I -ivory

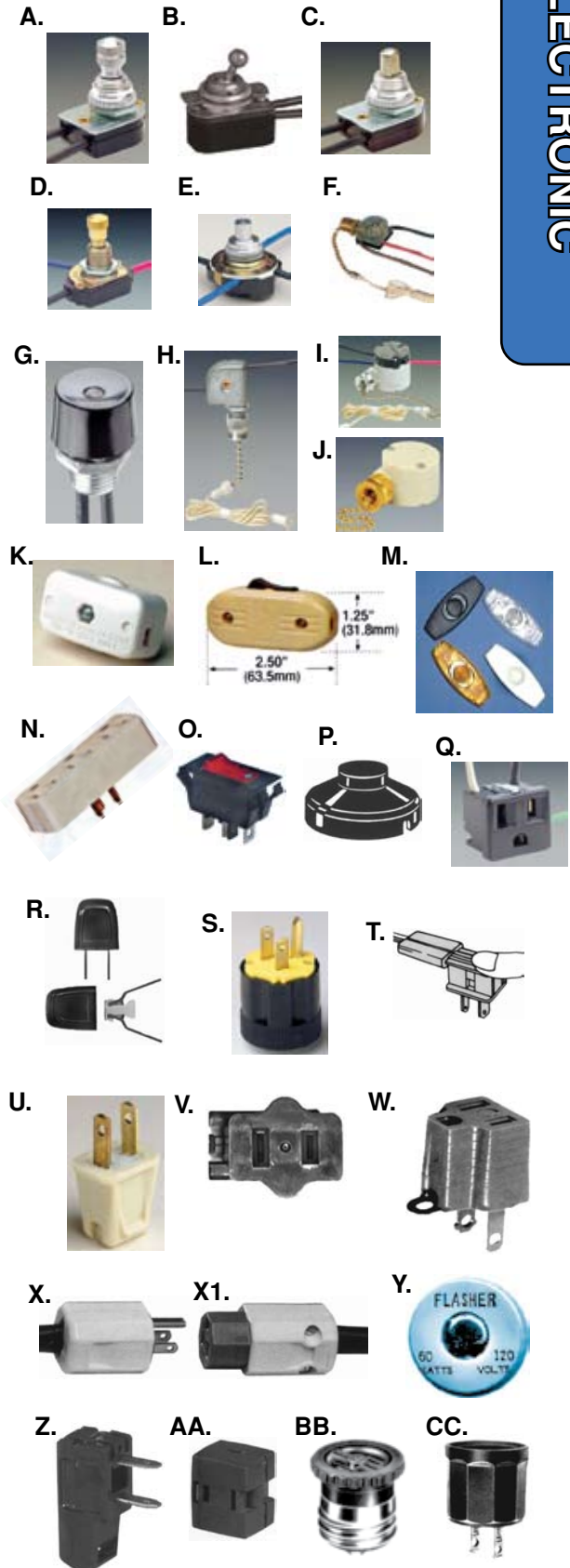

USA & CANADA

1-800-445-6611

FAX WATS 1-800-445-6690



Visit us online at: www.lightingparts.com

PHOENIX, AZ

Phone: 602-268-0001

Fax: 602-268-0130

E-mail us at: customerservice@lightingparts.com

DIMMERS

Full Range Lamp Dimmers
For Incandescent or Quartz Lamps

- A. L6204 - 200W
- B. L6304 - 300W
- C. L6404 - 300W
- D. L6604 - 300W

Offset Shaft - 120V AC 50-60 Hz



1-1/2" L x 1-1/8" H x 1-1/8" W



2" L x 1-1/8" H x 1-1/8" W

Hi-Lo Feed-Thru Cord Dimmers

200W-120V

SPT-1

SPT-2

- A. L419 - brown
- B L419-I - ivory
- C. L419W - white
- A. L429 - brown
- B L429-I - ivory
- C. L429W - white



Rotary Type

No wiring needed

D150D - 150W



Clamp-On Slide Dimmer

use with SPT-2 wire

DAR170

Full range dimming. Color - white.
LED nightlight for easy access in dark 300 watts, 120V ac for incandescent or halogen bulbs



Pole Dimmer

500W-120

D5024

Halogen or Incandescent
L 5" x W 3/4" H 3/4"



Dimmer Knobs

- A. A5B - black
- B A5W - white
- C. A5C - chrome
- D. A5G - gold



Foot Control Dimmer

500W-120

D502

Halogen or Incandescent
LED Light Indicator Full Range Dimming
Fuse Protected



D503
10ft Cord
Only

Dimmer Knobs

L6120DB



3 - Level Touch

120AC / U.L.

- A. D6503 - 150W
- B. D6503-300 - 300W



Manual Select Dimmers

Halogen or Incandescent
150W-120V

D500

L 1-3/4" x W. 1" x H. 3/4"



4 - Level Touch Dimmer

120AC VAC - 200W
Use with metal lamps

D135D



USA & CANADA

1-800-445-6611

FAX WATS 1-800-445-6690

Visit us online at: www.lightingparts.com



PHOENIX, AZ

Phone: 602-268-0001

Fax: 602-268-0130

E-mail us at: customerservice@lightingparts.com

DIMMERS & REMOTES**Plug-in Touch Dimmer
D145D - 200W**

4 - light levels use with
metal lamps

**Screw-in Touch Dimmer
D125 - 150W**

4 - light levels use with metal
lamps & metal sockets

**Heavy Duty Remote
D2190D**

Operate Christmas lights, lamps, T.V.,
stereo or other small appliances
Plugs into standard outlet approved for
wet locations 150 ft. range 12V battery
included. Indoor/Outdoor. 960W
incandescent fluorescent & halogen

**Touch Pad Dimmer
D155D - 200W**

4 - light levels

**Remote Plug-In Lamp Dimmer
D6000D - 300W**

turn light on/off & dim with remote
plugs into standard outlet full range
dimming 2- frequencies available
range 50 feet uses 9V battery (not
included). Indoor use.

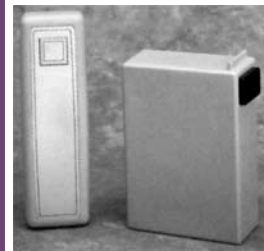
**Motion-Activated Light Control
D3600D - 600W**

Indoor / Outdoor

Turns light on when motion is detected.
Light shuts off 5 minutes after motion
stops. Override feature allows you to
turn light on and leave it on activation
switch allows day and night operation.
110° x 40' detecton zone, up to 100'
operating range.

Light Controls**A. D190D - 150W (medium base)**

Turns on at dusk & off at dawn
adjustable light sensor

B. D300D - 150W

Turns on at dusk & off at dawn

**Candelabra Base
MXP60 - 60W**

USA & CANADA

1-800-445-6611

FAX WATS 1-800-445-6690

Visit us online at: www.lightingparts.com

MILLER
O.E.M. SUPPLIES, INC.

PHOENIX, AZ

Phone: 602-268-0001

Fax: 602-268-0130

E-mail us at: customerservice@lightingparts.com

DIMMERS

Post Eye Light Control X-500

Operates Incandescent,
Fluorescent, Mercury Vapor
and Sodium Fixtures

Security & Safety

Outdoor / Automatic / Commercial
1800 Watts Max



Outdoor Stem Mount Light Control X-504

Operates Incandescent,
Fluorescent, Mercury Vapor and
Sodium Fixtures

Security & Safety

Outdoor / Automatic / Commercial
2000 Watts Max



Light Control with Weatherproof Plate X-501

Operates Incandescent,
Fluorescent, Mercury Vapor
and Sodium Fixtures

Security & Safety

Outdoor / Automatic / Commercial
1800 Watts Max



Outdoor/Indoor Home Finder Light Control X-505

Flip light switch twice and unit
flashes bulb to notify visitors.
Turns lights on at dusk,
off at dawn

Security & Safety

Flasher Feature / No-Flicker
100 Watts Max



Plug-In Table Top Lamp Dimmer X-502

Converts any lamp to
Full Range Dimming

Plug-In / Full Range Control
300 Watts Max



Screw-In Floodlight Control X-506 Security & Safety

Long stem design fits inside
most outdoor PAR Type Fixtures
Screw-In / Outdoor / Automatic
150Watts Max



Touch Dimmer X-503

Converts any lamp to
3-Level Dimming

Plug-In / 3-Level Control
300 Watts Max



Remote Control System Wall Mounted Switch & Plug-In Receiver X-507

Works up to 100 ft. away - even
around corners. Easy to use.
Transmitter battery included.

Wireless RF Signal Travels
From Wall Switch to Receiver



USA & CANADA
1-800-445-6611
FAX WATS 1-800-445-6690

MILLER
O.E.M. SUPPLIES, INC.

PHOENIX, AZ
Phone: 602-268-0001
Fax: 602-268-0130

Visit us online at: www.lightingparts.com

E-mail us at: customerservice@lightingparts.com

DIMMERS

Remote Control System
Hand Held Transmitter & Plug-In Receiver
X-508

Control lights and appliances inside or outside your home without any wiring. Works up to 100 ft. Easy to use. Includes Transmitter Battery.

Wireless RF Signal Travels From Keychain Transmitter to Receiver



Swivel Mount Light Control
X-5011

Operates Incandescent, Fluorescent, Mercury Vapor and Sodium Fixtures. Turns lights on at dusk, off at dawn.

Security & Safety

Outdoor / Automatic / Commercial
1800 Watts Max



Outdoor/Indoor Candelabra Light Control

X-509

Turns incandescent candelabra-based light bulbs on at dusk, off at dawn

Security & Safety

Screw-In / No-Flicker
60 Watts Max



Outdoor/Indoor Programmable Light Control

X-5012

Turns incandescent light bulbs on at dusk, off at programmed time

Screw-In / Digital Reliability / No-Flicker / 100 Watts Max



Outdoor/Indoor Light Control

X-5010

Turns incandescent light bulbs on at dusk, off at dawn

Screw-In / 150 Watts Max



Outdoor/Indoor Light Control

X-5013

Turns incandescent light bulbs on at dusk, off at dawn

Screw-In / 150 Watts Max



TOUCHLESS SENSOR DIMMERS

Touchless Sensor Dimmer

A. TSD1

Dimmer and Switch (On/Off)

B. TSD2

Switch (On/Off) Only

One wave of your hand activates the Touchless Sensor Dimmer to turn your lamp on or off. Move your hand up and down to dim light up or to dim light down WITHOUT PHYSICALLY TOUCHING THE LAMP! Perfect for many different uses and applications. Dimming range reaches up to 6 inches. 120 Volts / 60 Hz / 2.5 A / 100W

REVOLUTIONARY NEW LIGHT DIMMER



USA & CANADA

1-800-445-6611

FAX WATS 1-800-445-6690

Visit us online at: www.lightingparts.com



PHOENIX, AZ

Phone: 602-268-0001

Fax: 602-268-0130

E-mail us at: customerservice@lightingparts.com

DIMMERS & REMOTES

Plug-in Touch Dimmer T-30 A

- Size: 55 x 47 x 19 mm
- Input: 120V AC 60Hz
- Output: 300W Max
- Description 3 level Dimmer with 10' primary lead SPT-2 cable with US standard plug 2" secondary lead SPT-2 Cable with 3 multiple outlets, 10' touch lead with round touch pad.
- Function 3 level Dimming (25%, 50%, 100%) and off, can work any regular light (such as incandescent and halogen light...etc) except the fluorescent fixtures.



Plug-in Touch Dimmer T-30B

- Size: 55 x 47 x 19 mm
- Input: 120V AC 60Hz
- Output: 300W Max
- Description: Full Range Touch Dimmer with 10' primary lead SPT-2 cable with US standard plug, 2" secondary lead SPT-2 Cable with 3 multiple outlets, 10' touch lead with round touch pad.
- Function Full Range Dimming and off, easy control to get any lumenicity you want (touch to light up, lamp touching and stop at the lumenicity you want) except the fluorescent fixtures



Plug-in Touch Dimmer T-30C-1

- Size: 55 x 47 x 19 mm
- Input: 120V AC 60Hz
- Output: 300W Max
- Description: Touch Dimmer with 6" input & output lead SPT-2 cable with Male & Female connector, 10 touch lead with round touch pad.
- Function: Full Range Dimming and off, easy control to get any lumenicity you want (touch to light up, lamp touching and stop at the lumenicity you want) except the fluorescent fixtures



Plug-in Touch Dimmer MJB-01

- Size: 50 x 40 x 19 mm
- Input: 100V AC 60Hz
- Output: 300W Max
- Description: Touch Dimmer with 6" input & output lead
- Function 3 level Dimming (25%, 50%, 100%) and off, can work any regular light (such as incandescent and halogen light...etc) except the fluorescent fixtures.

MJB-01

FEATURES:

- Size: 50 x 40 x 19 mm
- Input: 120V AC 60Hz
- Output: 300W Max
- Description: Touch Dimmer with 6" input & output lead
- Function: Same as T-30A or T-30B

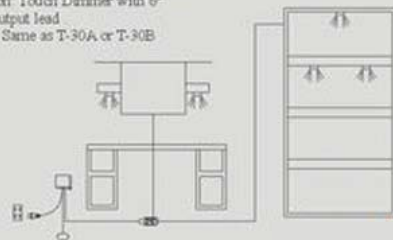

USA & CANADA

1-800-445-6611

FAX WATS 1-800-445-6690

Visit us online at: www.lightingparts.com

MILLER
O.E.M. SUPPLIES, INC.

PHOENIX, AZ

Phone: 602-268-0001

Fax: 602-268-0130

E-mail us at: customerservice@lightingparts.com

DIMMERS & REMOTES

MJB-01
 ■ SIZE: 120x70x40
 ■ INPUT: 120V AC 60Hz
 ■ OUTPUT: 6A
 ■ MATERIAL: Metal

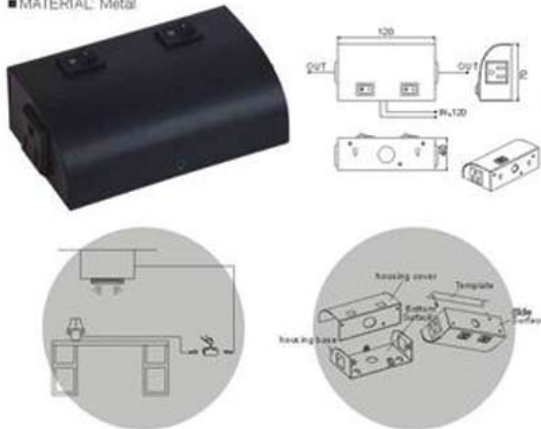

SMA-01
 ■ SIZE: 100.8x60.8x26.4
 ■ INPUT: 120V AC 60Hz
 ■ OUTPUT: 3A
 ■ MATERIAL: PC

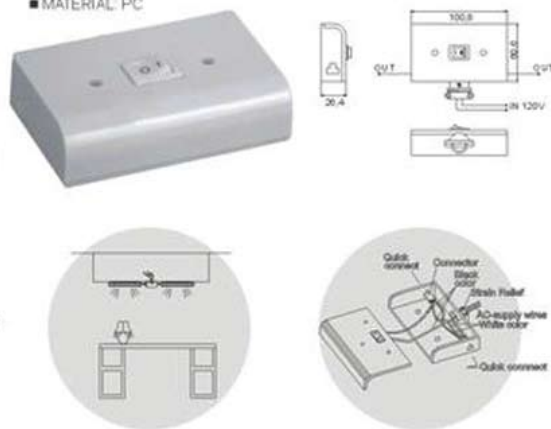

Plug-in Touch Dimmer

D145D - 200W

4 - light levels use with metal lamps



SIZE: ϕ 80x33
 MATERIAL: PC

- Rated voltage: 120V 60Hz
- Power: 200W
- Detection Range: 360° (Horizontal)
- 180° (Vertical); 240° (45° Angle)
- Detection Distance: 6Meters Max.
- Time Setting: 10 Seconds-5 Minutes

PIR-03



PIR-03
 ■ Size: 77.8x74x53mm
 ■ Material: PC
 ■ Input: 120V Ac 60Hz
 ■ Output: 300W

Automatic

Automatic turn on the light when you come in.
 Automatic turn off the light when you leave.

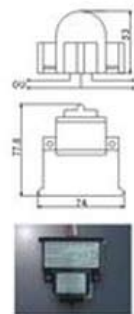

USA & CANADA
 1-800-445-6611
 FAX WATS 1-800-445-6690



PHOENIX, AZ
 Phone: 602-268-0001
 Fax: 602-268-0130

Visit us online at: www.lightingparts.com

E-mail us at: customerservice@lightingparts.com

AUTOMATIC ELECTRONIC PHOTOCELL

Auto Electronic Photocell

- Automatically turn light on at dusk
- Automatically turn light off at dawn
- Indoor/Outdoor use
- Suitable for incandescent & Fluorescent lights
- Easy installation



Auto Electronic Photocell

PC-07

100W - 120V AC 60Hz
Material: PC
Size: 30.5 x 28 x 21mm



Auto Electronic Photocell

PC-05

100W - 120V AC 60Hz
Material: PC
Size: 47 x 30 x 13.4mm



Auto Electronic Photocell

PC-08

300W - 120V AC 60Hz
Material: PC
Size: 48 x 37 x 16.5mm

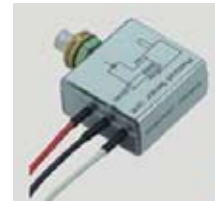

POWER SAVERS

Power Save

FEATURES:

- Easy to install
- Save 25% on your electric bill
- UL Approved & NASA tested
- Pays for itself in less than a year

Return on investment for the 3 phase could be just several months. Great for HVAC.

All units connect to your circuit breaker box. Installation time about 1/2 hour.

Save 25% on your electric bills.

Imagine a small gray box that fits neatly next to your breaker panel, saves you hundreds, if not thousands, of dollars year after year and protects the entire home. Sound too good to be true?

The Power-Save 1200™ was designed with the homeowner in mind, providing lower energy bills, increased motor and appliance life, as well as surge and lightning protection for all of the equipment inside of your house. Everyone who has an electric bill should have a Power-Save 1200™!

Residential customers throughout North America should see a realized savings of 8% - 10% minimum and as much as 25% on their electrical usage (and thus power bills). All Power-Save products are backed by a warranty for surge and lightning protection.



Power Save

FEATURES:

- Electrical Noise Reduction
- Power Factor Optimization
- Voltage Regulation

BENEFITS:

- Reduces electricity required by existing inductive loads
- Enhances capacity of existing electrical system
- Eliminates danger of harmful power surges on appliances and sensitive electronic equipment
- Reduces harmful effects caused by electrical noise in the electrical system

Specifications:

- Three Phase
- Utilizes Self-Healing Low Loss Capacitors
- 20 Year Design Life
- Surge Suppression – 2000 Joules
- Typical Protection For : Electrical Storms, Lightning Activity and Power •Utility Spikes
- Let Through Voltage – 150V line-to-neutral
- Load Rating – 20A (this means it discharges up to 20 amps at a time)
- Six-Way Electrical Protection
- EMI / RFI Noise Reduction 0-40dB
- Weight w/ packaging is 10.1 lbs.
- The PU 3200 is rated for a 200 amp inductive load
- The PU 3400 is rated for a 400 amp inductive load
- When installing the 3200 use a 30 amp three pole breaker
- When installing the 3400 use a 40 amp three pole breaker
- Either unit will work in a 208/480 environment
- Both units are in NEMA 3 rated 7" X 7" X 8" enclosures n.



USA & CANADA

1-800-445-6611

FAX WATS 1-800-445-6690

MILLER
O.E.M. SUPPLIES, INC.

PHOENIX, AZ

Phone: 602-268-0001

Fax: 602-268-0130

Visit us online at: www.lightingparts.com

E-mail us at: customerservice@lightingparts.com